



NEXSPAN2™ H SERIES SUBMITTAL PACKAGE

FOR OVERHEAD MEP APPLICATIONS

2	Introduction
3	Universal Clamps
4	Application Examples
5-6	NexSpan2™ v. Double C-Channel
7	Technical Specifications
7	Ordering Information



OVERVIEW & INFORMATION

Allfasteners NexSpan2™ H Series is a pre-engineered system for overhead MEP applications where heavy load capacities are required.

When it comes to challenging environments such as airports, data centers, hospitals, and waste/water treatment plants, NexSpan2™ H Series is the intersection between high load capacity and simplicity.

NexSpan2™ H Series consists of a slotted hollow structural tube design, universal beam clamps, and threaded rod, which ensure a quick, easy, and reliable support structure.



APPLICATIONS

- **Airports**
 - Heavy mechanical piping
 - Large HVAC ductwork
 - Industrial heating & cooling units
- **Data Centers**
 - Heavy chiller piping
 - Large HVAC ductwork
 - Industrial cooling equipment
- **Hospitals**
 - Large HVAC ductwork
 - Chemical process piping
 - Industrial heating & cooling units
- **Water/Waste Treatment Plants**
 - Pipe support stands & racks
- **Supplemental Steel**
- **Overhead Trapeze Applications**

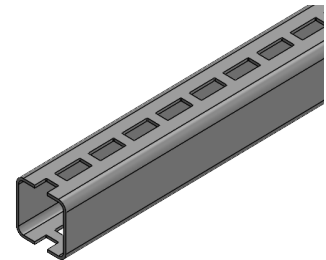

KEY BENEFITS

- Similar loading properties to welded steel frames
- No on-site welding needed
- No need for heavy lifting equipment
- Suited for installation in challenging environments
- Assembled with impact driver or torque wrench only
- Easy to level
- Hot dip galvanized
- Engineered structural support design
- Compact packaging allows for simple transport in the back of a van
- Cost effective
- Made in the USA
- Made by AISC Certified Fabricator



Certified AISC Fabricator
#2200111512ORFN

NOT A REPLACEMENT FOR STRUT CHANNEL

NexSpan2™ H Series superior load capacities allow it to go where strut channel cannot. The A500 grade hollow structural tube make it comparable to steel dunnage, I-beams, and double welded C-channel, and provide pre-engineered support for heavy pipework, large HVAC ductwork, HVAC units, and other suspended components.

By incorporating NexSpan2™ into your next project, you'll achieve superior results while minimizing design time, reducing welding hours on site, and avoiding the lead times associated with custom fabricated steel.



UNIVERSAL BEAM CLAMPS

The NexSpan2™ H Series is designed for overhead applications and can be securely mounted to I-beam flanges for use as supplemental steel.

Available in three sizes, 3", 4", and 5".

WHY USE NEXSPAN2™

- Lightweight, reducing handling labor and reducing weight carried by building structure. Modular design allows for quick adjustments and modifications
- Slotted design allows for quick length adjustments
- Sleek profile enhances aesthetic appeal and maximizes space efficiency
- Ideal for supporting electrical and mechanical systems, HVAC units, and other suspended components
- Provides reliable and safe hanging solutions for various construction needs
- Simplifies the installation process compared to traditional steel structures

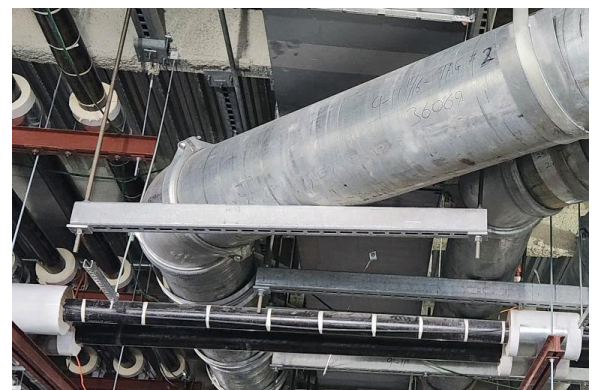
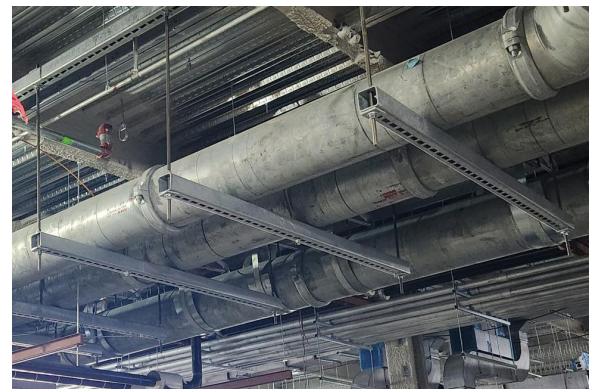

APPLICATION EXAMPLES

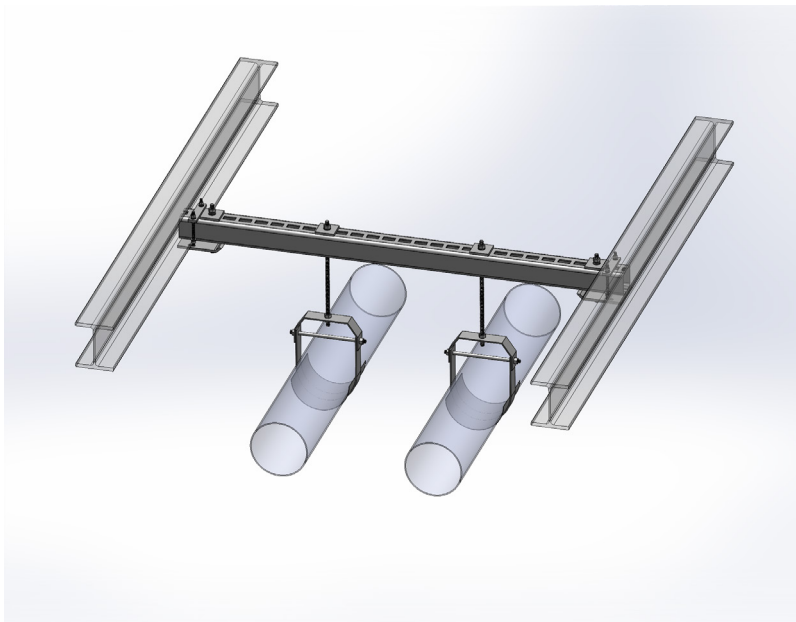
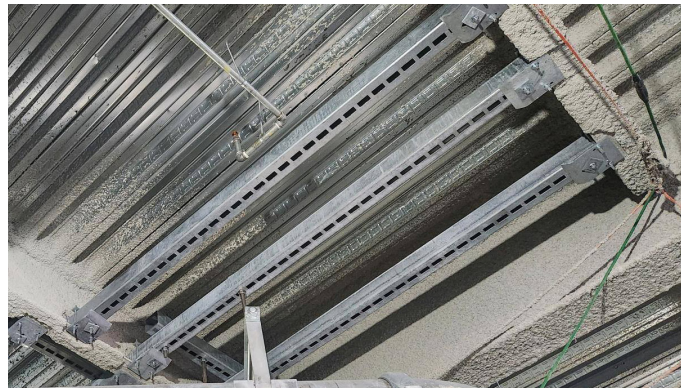
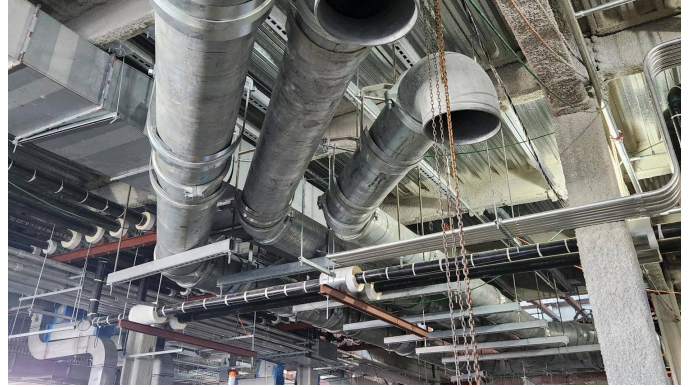

NEXSPAN2™ vs DOUBLE C-CHANNEL

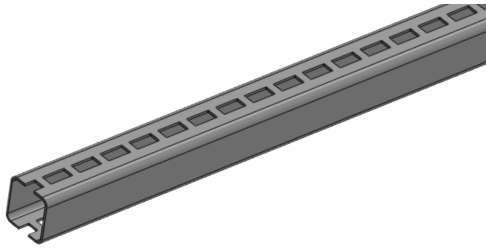

NEXSPAN2™ H SERIES



DOUBLE C-CHANNEL

TABLE 1: MAXIMUM ALLOWABLE LOADS

NEXSPAN2™ vs DOUBLE C-CHANNEL						
MAXIMUM ALLOWABLE LOAD (lbs.)						
SPAN (in.)	NEXSPAN2™ 3" x 3" x 1/4"	DOUBLE C3 x 4.1	NEXSPAN2™ 4" x 4" x 1/4"	DOUBLE C4 x 5.4	NEXSPAN2™ 5" x 5" x 1/4"	DOUBLE C5 x 6.7
36	2900	2900	5000	5100	9200	7900
48	2100	2200	3800	3800	6900	5900
60	1700	1700	3000	3000	5500	4700
72	1400	1400	2500	2500	4600	3900
84	1200	1200	2100	2100	3900	3400
96	1000	1100	1900	1900	3400	2900
108	700	900	1600	1700	3000	2600
120	600	800	1400	1500	2700	2300
132	–	800	–	1300	–	2100
144	–	–	–	1200	–	1900
156	–	–	–	1100	–	1800
168	–	–	–	1000	–	1700
180	–	–	–	–	–	1500
192	–	–	–	–	–	1400
204	–	–	–	–	–	1400

NEXSPAN2™ vs DOUBLE C-CHANNEL

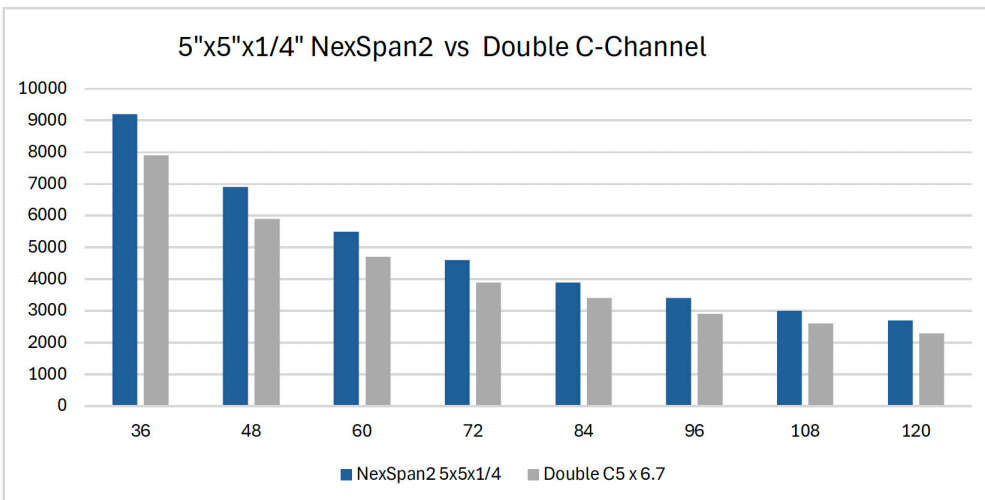
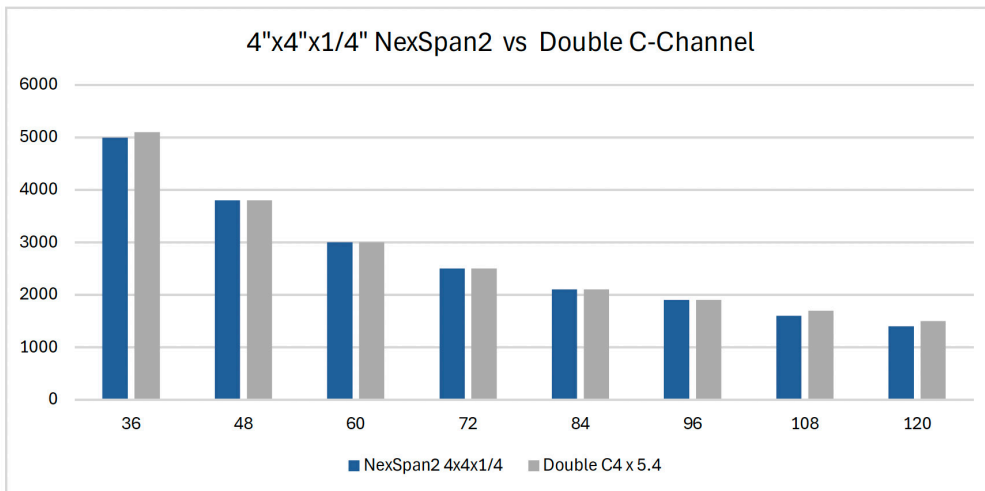
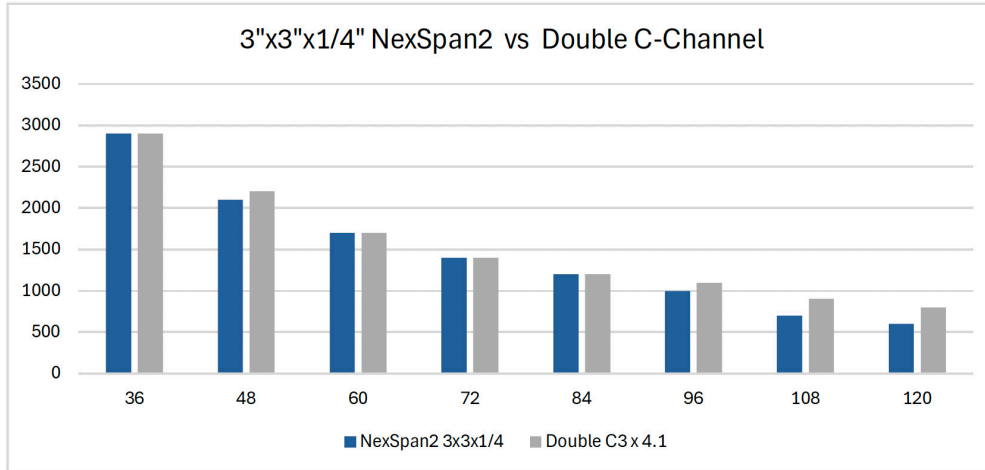

TECHNICAL SPECIFICATIONS

TABLE 2: NEXSPAN2™ H SERIES TECHNICAL DATA*

TUBE SIZE (in.)	t (in.)	t _{des} (in.)	SLOT WIDTH (in.)	A (in ²)	I (in ⁴)	S (in ³)
3.00	0.250	0.233	0.688	1.800	2.369	1.579
4.00	0.250	0.233	1.250	2.205	5.506	2.753
5.00	0.250	0.233	1.250	3.135	12.463	4.985

ASTM A500 Gr C. Hot Dip Galvanized per ASTM A123. Slot Lengths are 2-9/16".

ORDERING INFORMATION

TABLE 3: NEXSPAN2™ H SERIES ORDERING INFORMATION



PART #	SIZE	LENGTH	SLOT WIDTH
14NSH310	3 x 3 x 1/4"	10'	0.688"
14NSH410	4 x 4 x 1/4"	10'	1.250"
14NSH510	5 x 5 x 1/4"	10'	1.250"
14NSH320	3 x 3 x 1/4"	20'	0.688"
14NSH420	4 x 4 x 1/4"	20'	1.250"
14NSH520	5 x 5 x 1/4"	20'	1.250"

TABLE 4: NEXSPAN2™ UNIVERSAL CLAMP ORDERING INFORMATION



PART #	SIZE	FITS PART #
14NSHC3	3"	14NSH310 & 14NSH320
14NSHC4	4"	14NSH410 & 14NSH420
14NSHC5	5"	14NSH510 & 14NSH520

PROJECT INFORMATION		APPROVAL STAMP
PROJECT:		APPROVED
ADDRESS:		APPROVED AS NOTED
CONTRACTOR:		NOT APPROVED
ENGINEER:		REMARKS:
SUBMITTAL DATE:		
NOTES:		

**FOR ALL
THINGS
FASTENING.**



LOCATIONS NATIONWIDE

888.859.6060

24/7 ONLINE ORDERING

WWW.ALLFASTENERS.COM